



User Guide

Yale Unity[®] Slim Smart Lock

PIN Code | Yale Home App

Part of ASSA ABLOY



Yale Home



1. External Body (External Body, installation on the outside of the door)

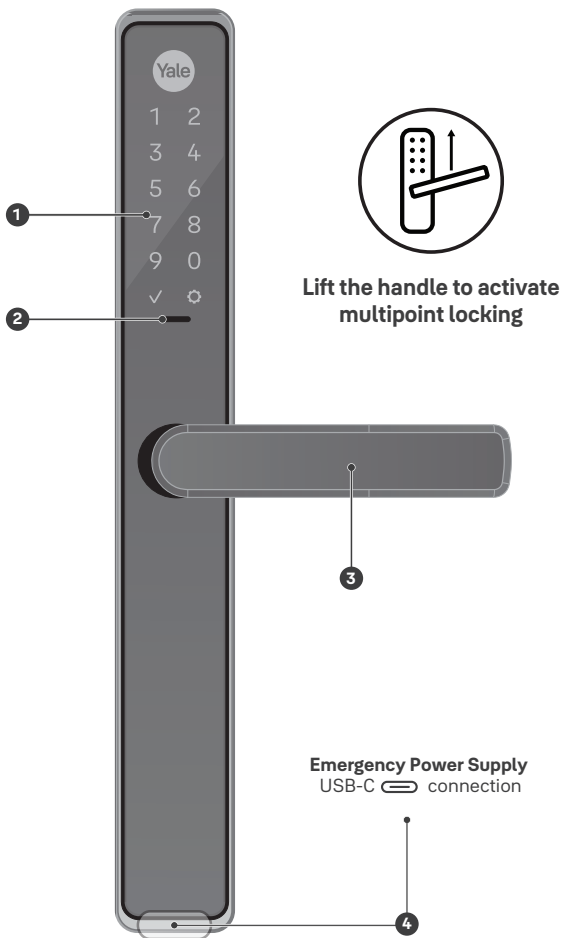

2. Internal Body (Internal Body, installation on the inside of the door)

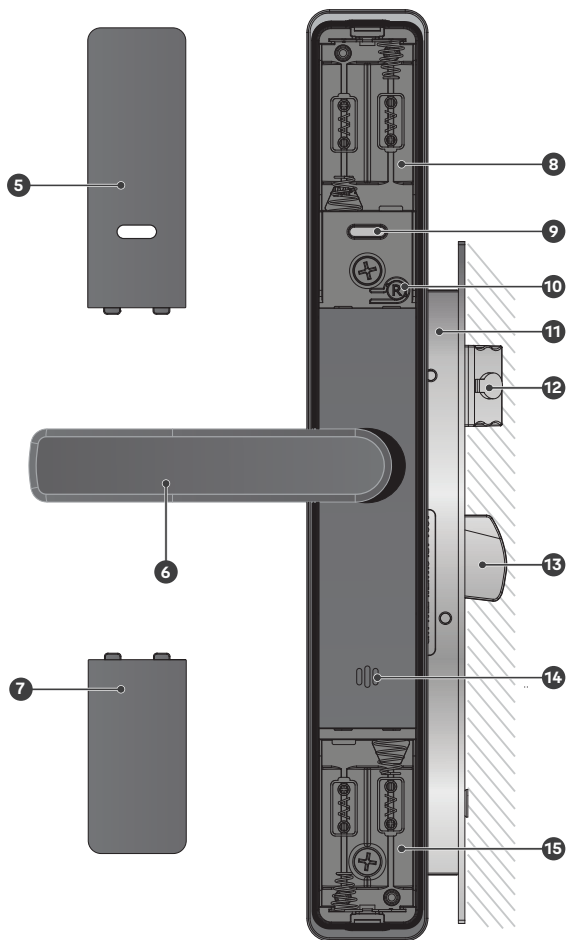

3. Reference Guide









1	Keypad
2	External LED indicator
3	External handle
4	Emergency power supply terminal
5	1 x (top) battery cover
6	Internal handle
7	1 x (bottom) battery cover
8	AA alkaline battery slots (top)
9	Status indicator button
10	® Registration button
11	Lock case (Yale Induro® 4-Point mortice lock shown)
12	Latchbolt
13	Deadbolt
14	Speaker hole
15	AA alkaline battery slots (bottom)

4. Specifications

Parts	Specifications	Remarks
External Body	37.5(W) X 287(H) X 49(D) mm	Operating temperature: -15 ~55°C (5 ~131°F)
Internal Body	37.5(W) X 287(H) X 49(D) mm	
Optional Accessories	Connect Plus Hub 2**	

**Adding the Connect Plus Hub 2 to your Yale Unity Slim Smart Lock allows you to access your lock from wherever you are using the Yale Home App.

5. Setting Menu Icons

	Touch the keypad of the external body with your palm to begin.	
	Press ✓ button on the keypad.	
	Press ⚙️ button on the keypad.	
	Registration button	Press Ⓜ️ (registration) button to start or complete the session.
	Enter user code (6 digits only)	The user code is used to unlock the lock. (Up to 100 users)
	Enter master code (6 digits only)	The master code is required for accessing the setting menu.
	Enter one-time code (6 digits only)	The one-time code is used for unlocking the lock. It will be automatically deleted once it is used.
	User slot number (2 digits only)	'01' for user slot number 1, '02' for user slot number 2. '00' for user slot number 100.

Ensure the secure storage of the master code, it can only be changed via the keypad, not in the app. In the event the master code is lost, a factory reset is required.

6. Lock Setup Using The Yale Home App (Recommended)

Setting up the lock using the Yale Home App is recommended as it grants more features and enhances the overall convenience of your smart lock. If you choose to set up the lock without connecting to the Yale Home App, refer to section 7.



Connecting Your Lock To The Yale Home App

1. Register your Master Code on your lock:



2. Download the Yale Home App.

3. Log in or create a Yale Home App account.

4. Select "Set up new device".

5. Scan the QR code behind the top battery cover or on the box.

6. Activate App Pairing Mode on your lock. This mode is active for 5 minutes.



7. Complete setup using the Yale Home App.

Important: Once connected to your Yale Home App, all lock settings except the master code will be restored to default and the following features can only be customised using the app:

- User codes
- One-time codes
- Auto-lock
- Volume control
- Auto-unlock

7. Lock Setup (Yale Home App not connected)

Important: Connecting to your Yale Home App will restore all lock default settings in this section, except the master code.

Register Master Code (Use during initial registration or after a factory reset)													
Registration										Only 1 User			
Changing Master Code													
Registration			1									OR	
User Code (6 digits only) Up to 100 Users													
Registration			2		1		UN		U			OR	
Delete			2		3		UN						
One-time Code (6 digits only) Only 1 User, Automatically deleted after use													
Registration			4		1		0						
Delete			4		3		M						
Delete All User Codes (Except master code)													
Delete			5										
Auto-Lock (Default time is 10 seconds)													
Enable			6		2		1						
Disable			6		2		3						
Volume Control													
High							1						
Low			6		3		2						
Silent							3						

8. Product Features (1)



Total Control Via The App

The Yale Home App allows you to lock and unlock your door, grant access to others and keep track of visitor access.



Smart Home Integration

Monitor access, lock and unlock your door from anywhere when you upgrade with the Yale Connect Plus Hub 2** and integrate into a compatible home automation or security system.



Auto-Lock

Automatically lock within a specified time after closing the door. The default auto-lock time is 10 seconds. When this feature is enabled and the lock is not in silent mode, it will beep when the door is closed to signify auto-lock will activate soon.



Auto-Unlock

The auto-unlock feature allows your door to unlock as you approach your door, using a combination of your smartphone's Bluetooth, Wi-Fi and GPS technologies to do so. For more information, refer to the Yale Home App. Note: this feature can only be enabled and customised using the app.



Multipoint Locking

When entering or leaving, activate multipoint locking by closing the door, lifting and releasing the handle. Note: for the outside handle, this must be done before lock auto-locks (if enabled).



Emergency Power Supply

In the case the batteries are depleted, emergency power can be delivered to the lock using a power source and a USB-C  connection.

9. Product Features (2)

Fake PIN Code

This feature allows any number of digits to be entered before or after a user code to prevent the code from being exposed.



3-Minute Lockout

3-minute lockout will activate after 5 failed code attempts, preventing unauthorised access through the keypad for 3 minutes.



Security Lockout Mode

This mode disables the external keypad and lock control using the app. The Security Lockout Mode can be enabled by holding down the status indicator button for 4 seconds, until the voice prompt is heard.



Internal Intrusion Alarm

This alarm can be activated to sound if the door is opened from the inside. To activate, enter the Master Code and hold the gear key.



Tamper Alarm

This alarm will sound if the external body cable is separated from the internal body or if someone forces the door open.



Voice Prompts

Effortlessly directs you to enable different features and settings, ensuring an even simpler and more convenient user experience.



Other features and benefits:

- Stores up to 100 user codes
- Designed to be used with the Yale Induro® 4-Point Lock for increased security with four points of locking and additional seal compression

10. Using Your Lock

Entering Your Home

1. Unlock using the keypad, Yale Home App or auto-unlock (if enabled via the app). Access from inside can also be granted using the status indicator button.
2. When unlocked, pull the handle down to open the door.
3. Once inside, lift and release inside handle to activate multipoint locking.

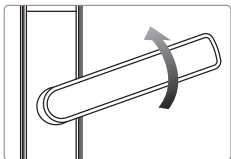

Leaving Your Home

1. Push handle down to unlock and open door.
2. Once outside, lift and release outside handle to activate multipoint locking.

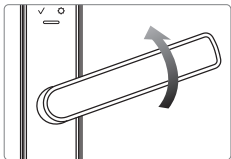

Other ways to lock your door:

- Auto-lock (if enabled)
- Status indicator button (on inside)
- The Yale Home App

Note: If these methods are used to lock the door, multipoint locking can only be activated by lifting and releasing the inside handle.

11. Unlocking Using Keypad

With User Codes



With Fake Codes

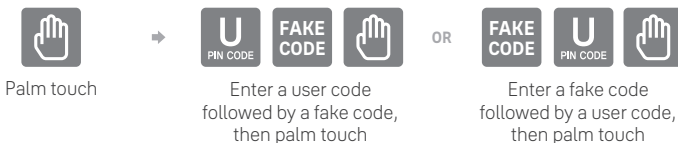
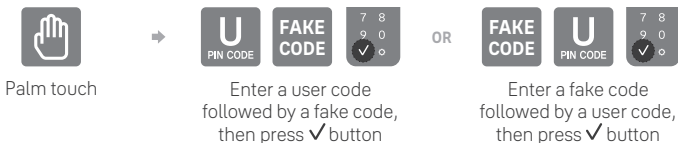

12. Deactivating Modes and Alarms

Disabling Security Lockout Mode

- Hold down the internal status indicator button for 4 seconds until the voice prompt is heard.

OR

- Push down the handle from the inside and open door.
-

Disabling Internal Intrusion Alarm & Tamper Alarm

If an alarm is triggered, follow these steps to turn off the alarm.

- Enter a registered user code.

OR

- Press **(R)** button for five seconds.
-

Disabling 3-Minute Lockout

If the 3-minute lockout is triggered, follow these steps to disable it.

- Open the door with the internal handle.

OR

- Press **(R)** button.

13. Troubleshooting (1)

Emergency Power Supply

In the event the AA batteries have lost charge, a USB-C and a power source can be used as a temporary power source. The USB-C port can be found on the underside of the external body.

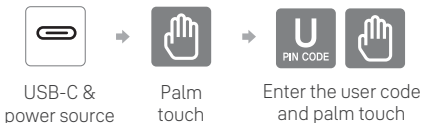

Low Battery Alerts

You must replace all 4 batteries in the following cases:

- Low battery warning: the external LED on keypad flickers red and "replace the batteries" is heard when locking or unlocking.
- Low battery notification message is displayed in the app.

RISK OF EXPLOSION IF BATTERY IS REPLACED BY AN INCORRECT TYPE. DISPOSE OF USED BATTERIES ACCORDING TO THE NATIONAL CODE OR RECYCLING PROGRAM.

Warning

USE ONLY **ALKALINE** BATTERIES*. DO NOT USE LITHIUM OR RECHARGABLE BATTERIES BECAUSE THEY MAY CAUSE THE LOCK TO MALFUNCTION

*4x New alkaline batteries may last for 1 year with a usage of 10 times a day. Battery life depends on factors like usage habits, temperature, humidity, and battery quality.

LED Status Indication

- **Door is unlocked:** External and Internal LED flashes **Green**
- **Door is locked:** External and Internal LED flashes **Red**
- **Security lockout mode is active:** External and Internal LED flashes **Blue**
- **Low battery warning:** External LED only flashes **Red**

14. Troubleshooting (2)

Restoring Default Settings

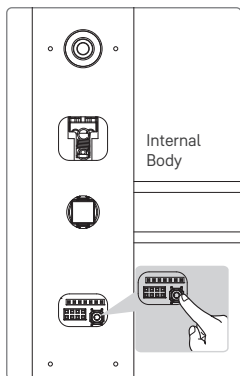

Restoring default settings deletes all user codes **(including the master code)** and all programming features are reset to the default.

1. Remove the battery covers and batteries.
2. Remove the internal body to access the reset button shown.
3. Press and hold the reset button.
4. While pressing reset button, reinstall batteries.
5. Once the “completed” voice prompt is heard, release reset button. The voice prompt will be heard 10s after the batteries have been reinstalled.
6. Replace battery cover.

After restoring default settings, master code creation is the only option available and must be performed prior to programming other features on the lock.

If your lock is connected to your Yale Home App account, restoring default settings will not disconnect your app account with the lock.

Important: If transferring ownership of the lock, both factory resetting with the Yale Home App (if connected) and restoring default settings must be completed.

Factory Resetting With The Yale Home App

Factory resetting the lock with the Yale Home App disconnects your Yale Home App account with your lock.

1. Go to “Lock Settings” using the Yale Home App.
2. Select “Factory Reset” and follow the prompts, waiting for the “Completed” voice prompt on your lock.

Important: If transferring ownership of the lock, both factory resetting with the Yale Home App (if connected) and restoring default settings must be completed.

15. Safety & Warnings

- This product is suitable for residential applications on entry doors. It is not suitable for entry points where the escutcheon is exposed to outdoor elements (e.g. on a gate). The components and design of this product are subject to change without prior notice for performance and quality improvement.
- Do not attempt to disassemble the digital door lock by yourself. By doing so, you may get an electronic shock and damage the product.
- Do not use force with a tool onto the product.
- Make sure to lock your door when you go out by latching the door tightly then lifting and releasing the handle to enable multipoint locking.
- Do not use water or any type of solvent to clean the product such as gasoline or benzene as they can cause damage to electronic circuit, deterioration and or paint peel-off.
- It is recommended to change user code(s) on a regular basis.
- Do not use rechargeable or lithium batteries. Only alkaline batteries are recommended.
- The performance of the product shall not be guaranteed under unintended conditions, including but not limited to instances of water condensation and applications in seaside environments.
- Warranty will not cover- exposure to dampness, excessive heat, excessive humidity and other extreme environmental conditions, corrosion, damage beyond repair, rusting, unauthorised modifications, unauthorised repairs, neglect, accident, alteration, acts of God, spillage of liquid or food particles.

PLEASE READ INSTRUCTIONS BEFORE USE.
The functions and design of this product can be changed
without prior notice for performance and quality improvement.

ISSUE: 04062024_V1

ASSA ABLOY New Zealand Ltd
6 Armstrong Road, Albany, Auckland,
0632, New Zealand
yalehome.com/nz | For customer
feedback: nzsales@assaabloy.com

ASSA ABLOY Australia Pty Ltd
235 Huntingdale Road Oakleigh,
Victoria, 3166 Australia
1300 LOCK UP (1300 562 587) |
yalehome.com/au



Part of ASSA ALOY